

Étape 1

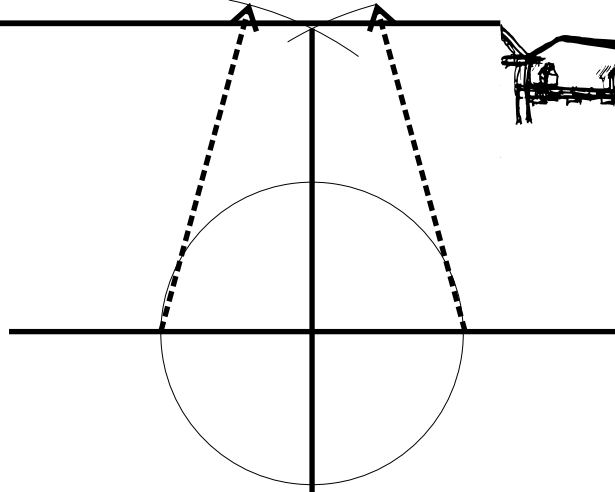

Étape 2

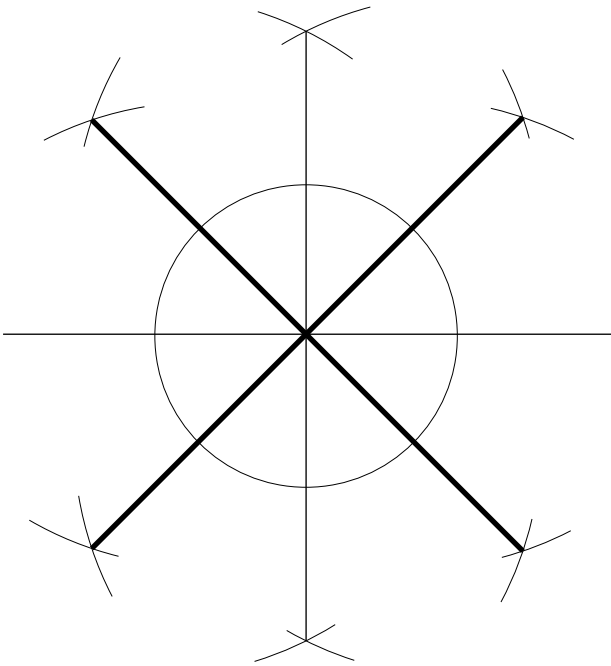

Étape 3

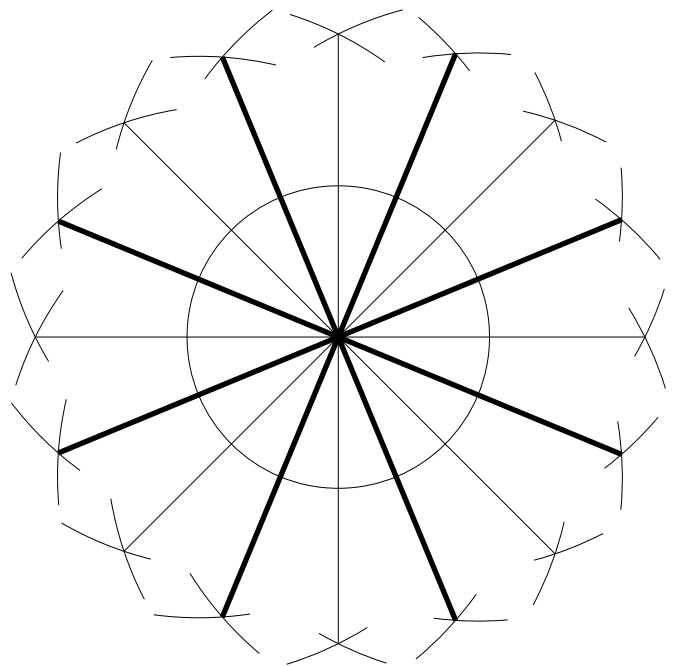

Étape 4

Pentagone

L'hexadécagone régulier est un polygone régulier, c'est-à-dire qu'il s'agit d'un polygone convexe dont les 16 côtés ont la même longueur et les 16 angles la même mesure.

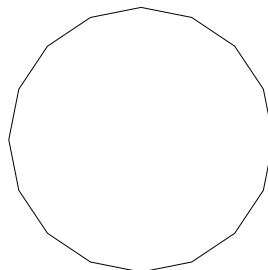

Chaque angle interne mesure $157,5^\circ$; la somme des 16 angles internes atteint $2\ 520^\circ$. Chaque angle au centre de l'hexadécagone mesure $22,5^\circ$.

L. Bodart

Éch:

Date:

Nom

Construction géométrique

Classe:

L'hexadécagone

Exe:



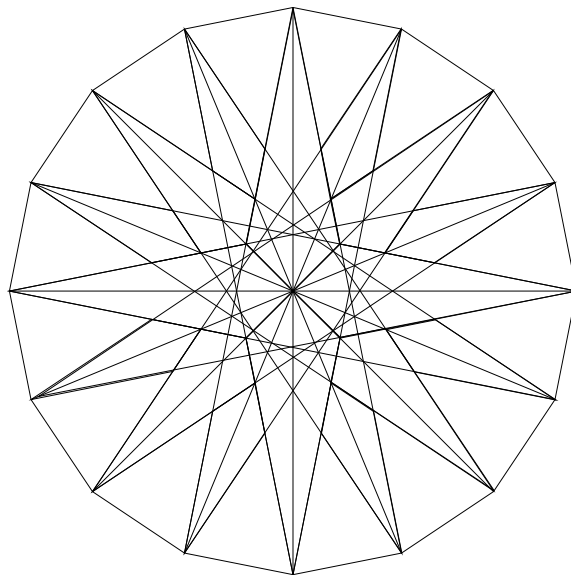
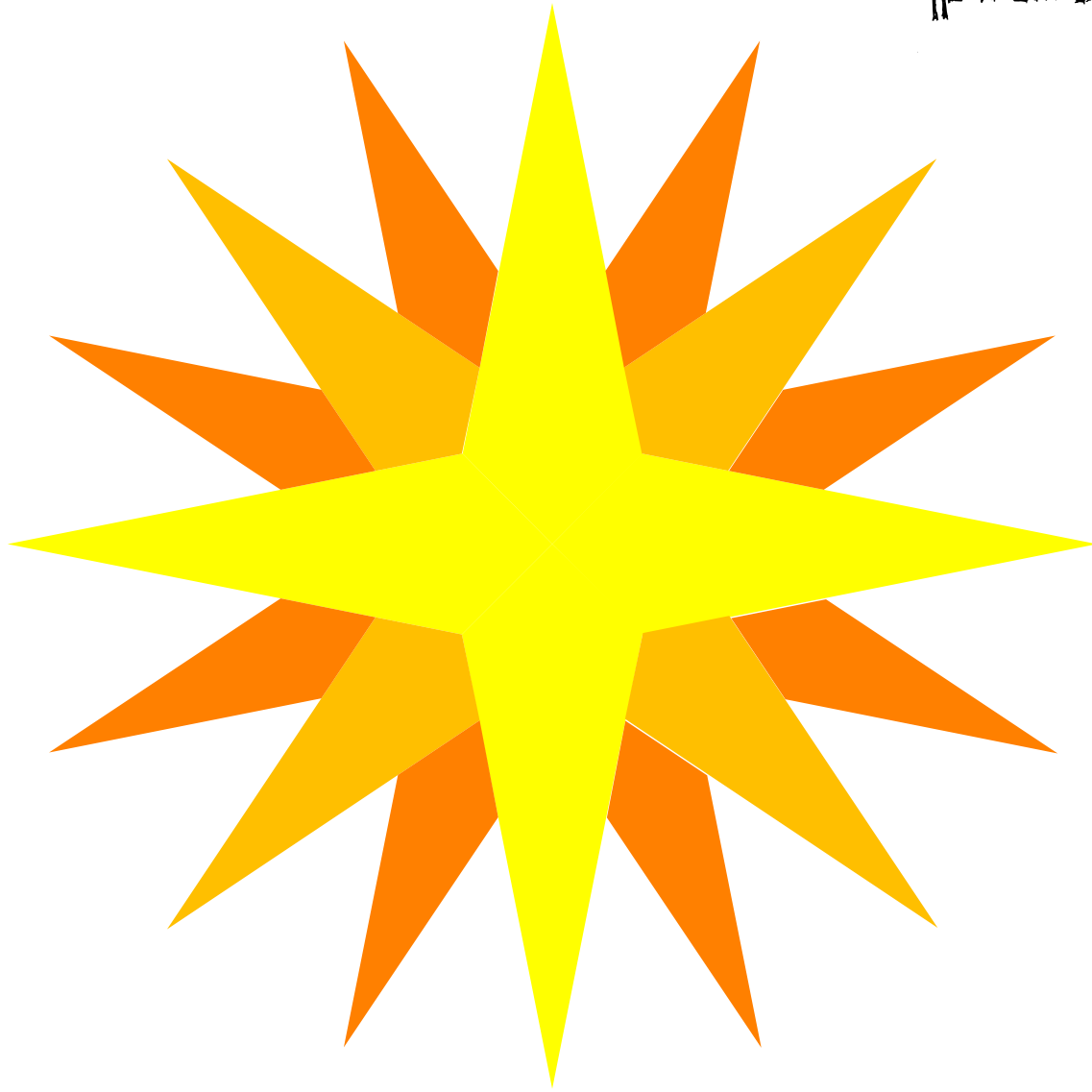

L. Bodart

Éch:

Date:

Nom

Construction géométrique

L'hexadécagone

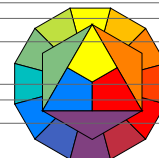

Classe:

Exe:



[Http://eqba.collegesaintandre.be/](http://eqba.collegesaintandre.be/)

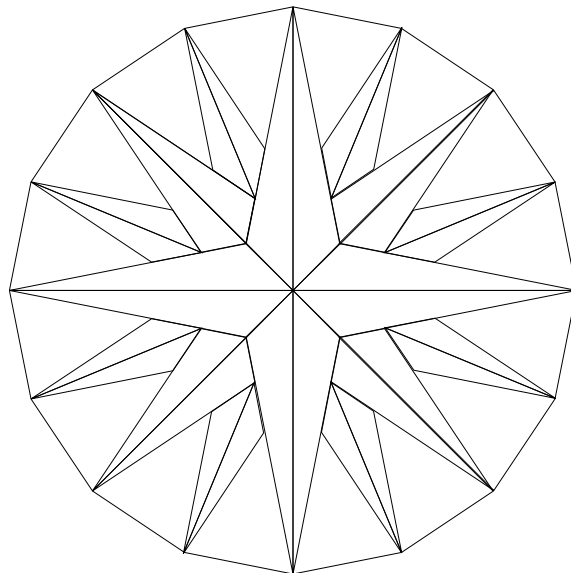
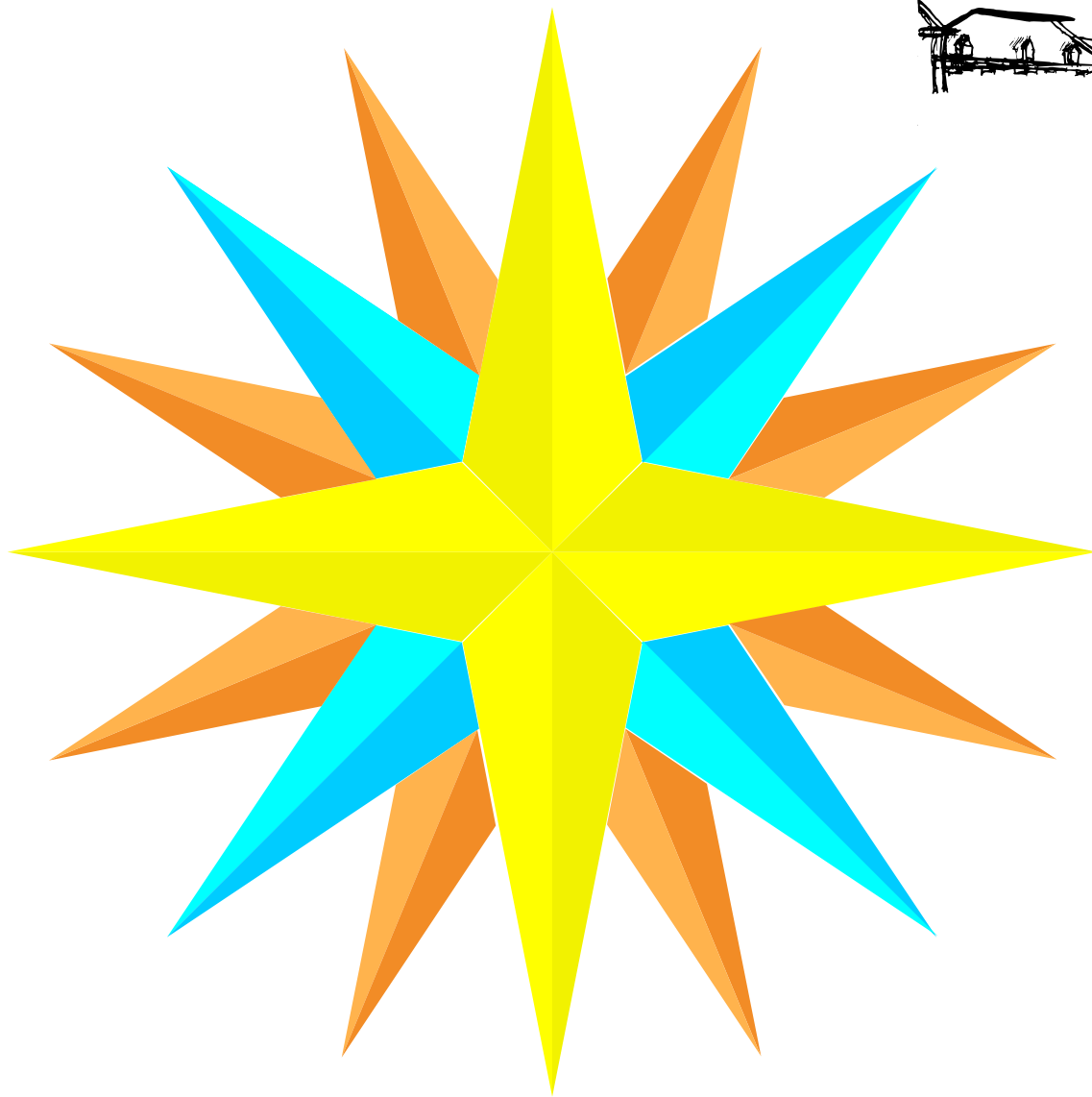

L. Bodart

Éch:

Date:

Nom

Construction géométrique

L'hexadécagone

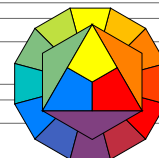

Classe:

Exe:



[Http://eqba.collegesaintandre.be/](http://eqba.collegesaintandre.be/)

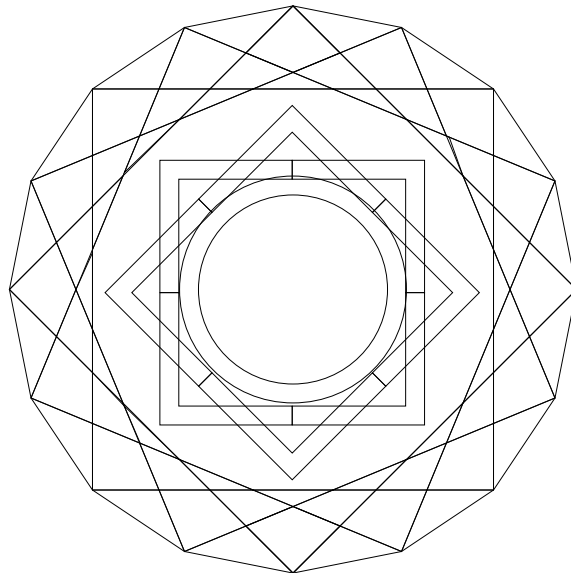
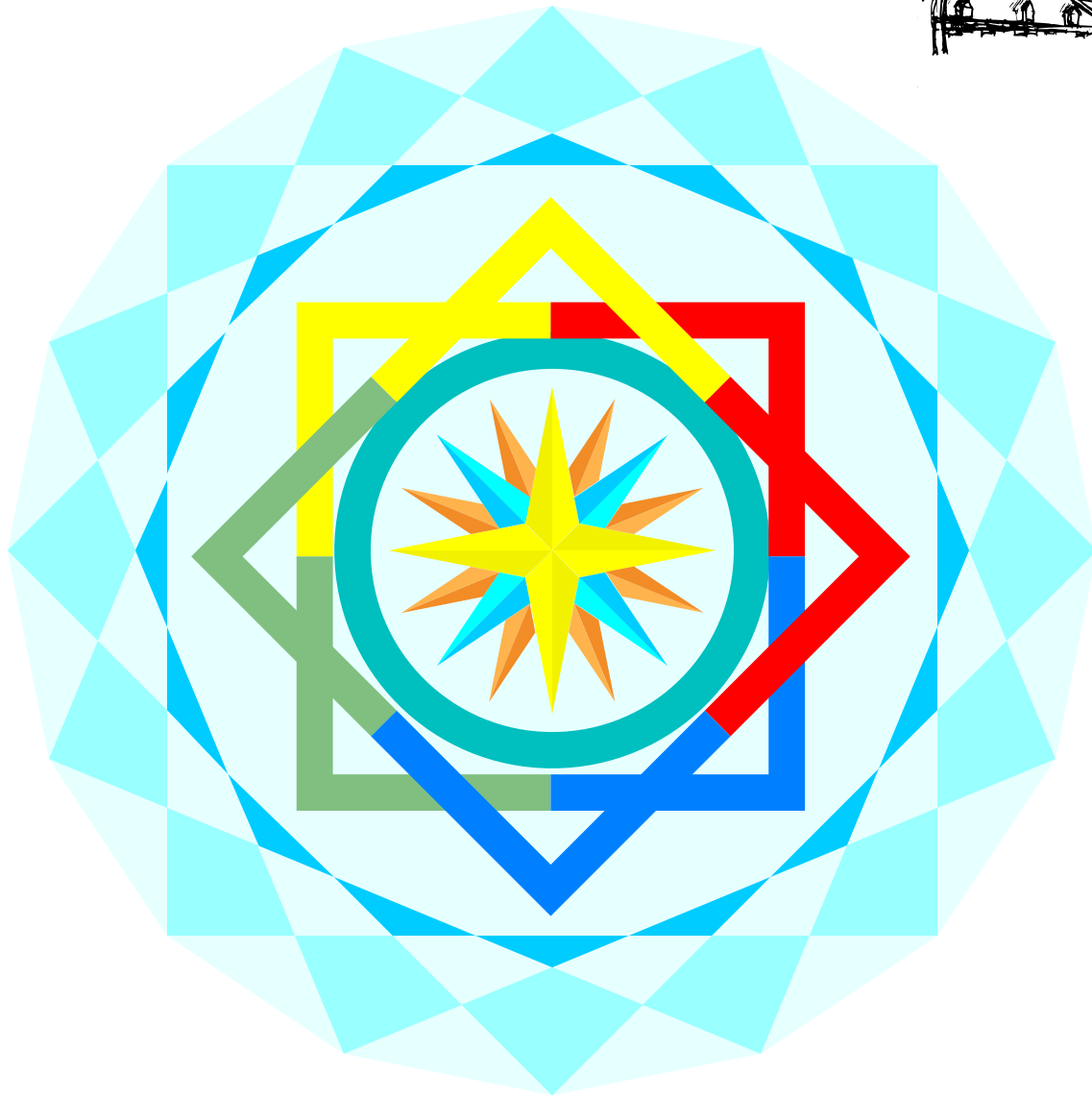

L. Bodart

Éch:

Date:

Nom

Construction géométrique

L'hexadécagone

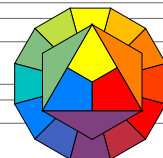

Classe:

Exe:



[Http://eqba.collegesaintandre.be/](http://eqba.collegesaintandre.be/)