

Déplacement



L. Bodart

Éch: \_\_\_\_\_ Date: \_\_\_\_\_ Nom \_\_\_\_\_

Construction géométrique

Classe: \_\_\_\_\_

Les parallèles, perpendiculaires

Exe: \_\_\_\_\_





# Tracer une perpendiculaires à partir d'un point avec une latte et une équerre

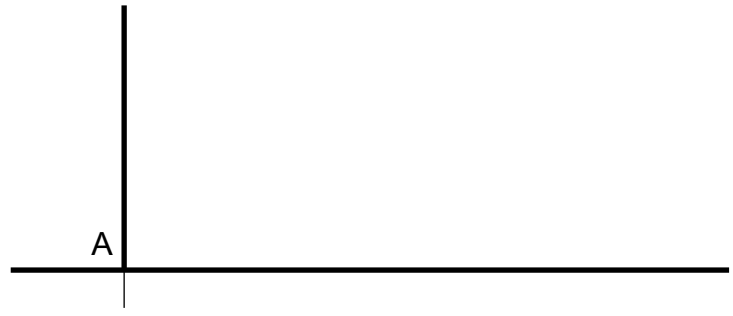
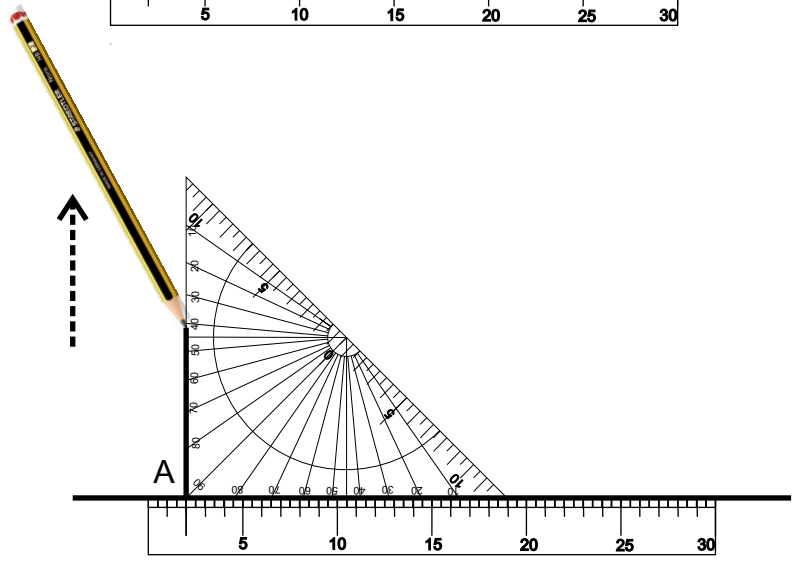
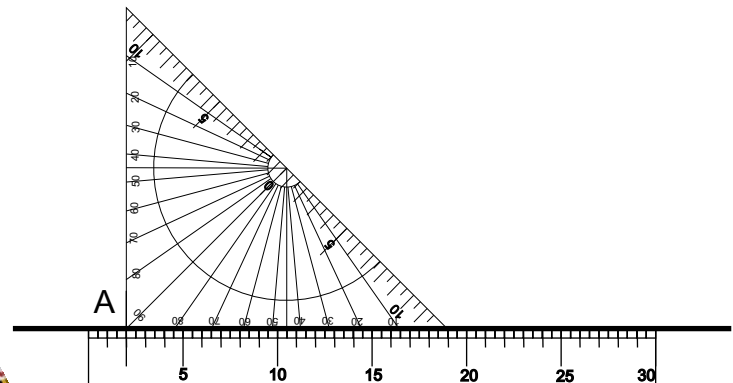
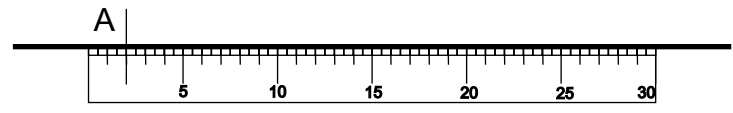

L. Bodart

Éch: _____	Date: _____	Nom _____
------------	-------------	-----------

Construction géométrique

Classe: \_\_\_\_\_

Les parallèles, perpendiculaires

Exe: \_\_\_\_\_





# Tracer des parallèles distantes de 10 mm à partir d'une droite avec une latte et une équerre

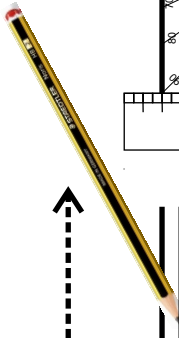
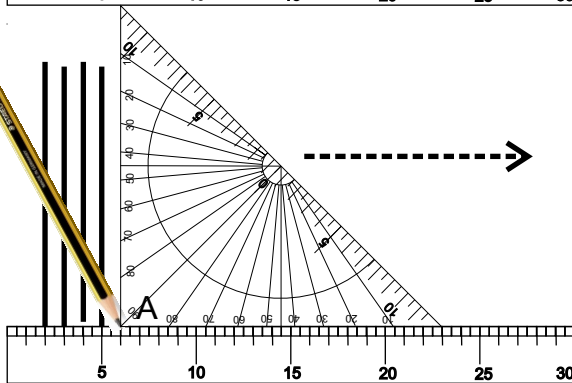
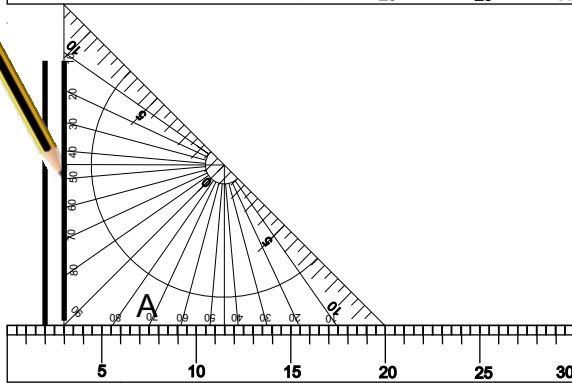
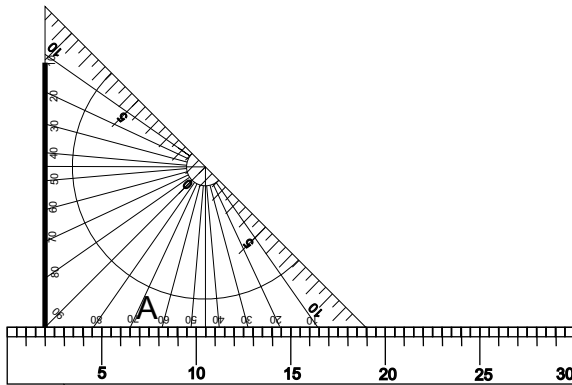
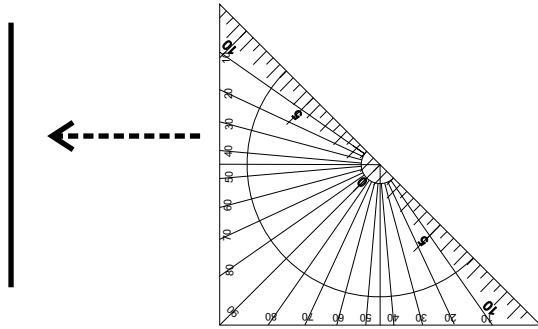

Attention au positionnement des instruments pour respecter les mesures demandées

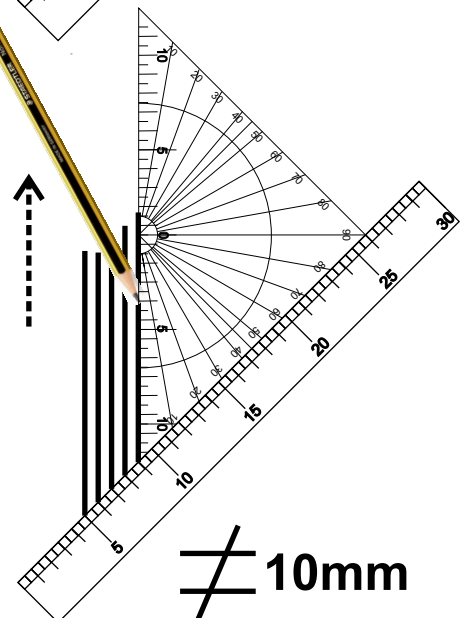
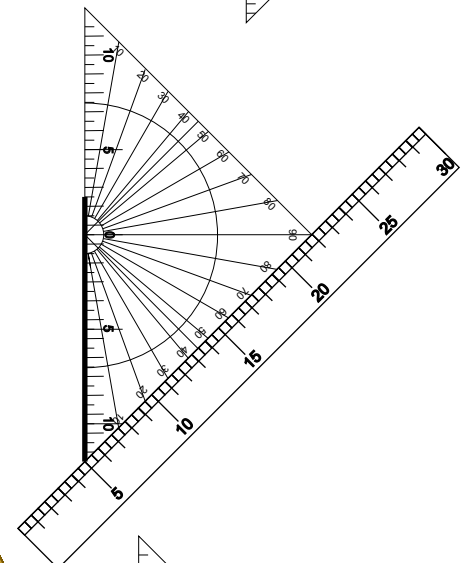
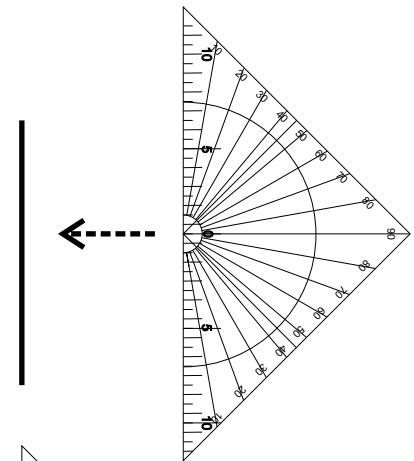

$\neq 10\text{mm}$

L. Bodart

Éch: \_\_\_\_\_ Date: \_\_\_\_\_ Nom \_\_\_\_\_

Construction géométrique  
Les parallèles, perpendiculaires

Classe: \_\_\_\_\_  
Exe: \_\_\_\_\_





Tracer des parallèles distantes de 10 mm  
ET perpendiculaire à partir d'une droite  
avec une latte et une équerre

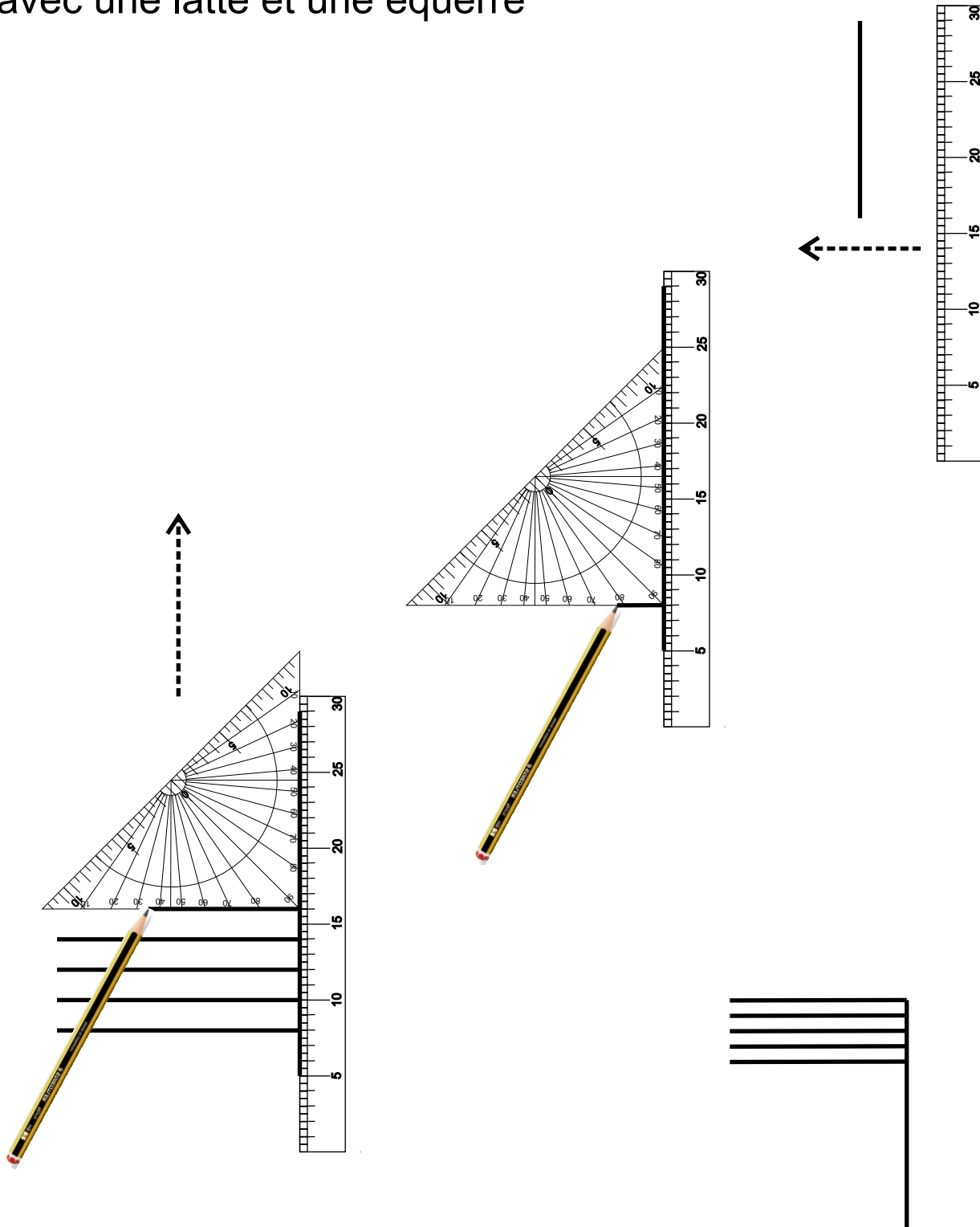

L. Bodart

Éch: \_\_\_\_\_ Date: \_\_\_\_\_ Nom \_\_\_\_\_

Construction géométrique

Classe: \_\_\_\_\_

Les parallèles, perpendiculaires

Exe: \_\_\_\_\_





Tracer des parallèles distantes de 10 mm  
ET perpendiculaire à partir d'une droite  
avec une latte et une équerre

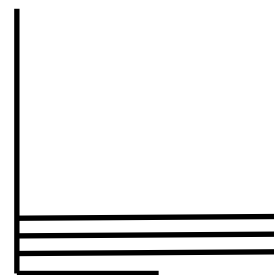
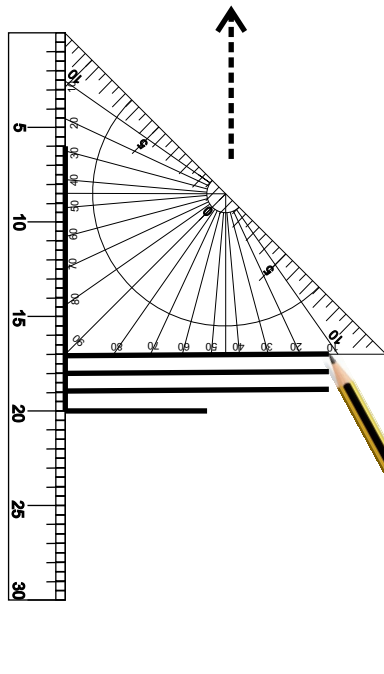
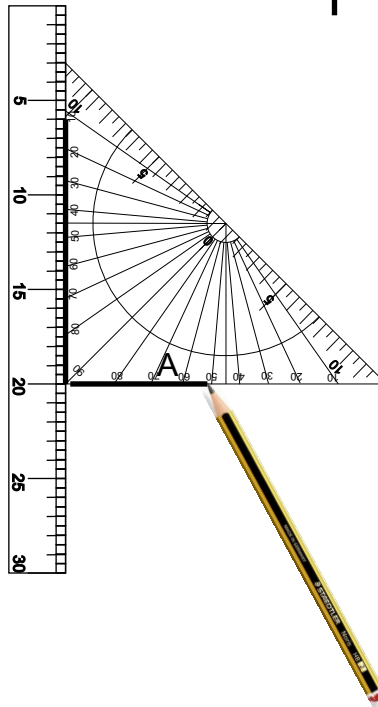
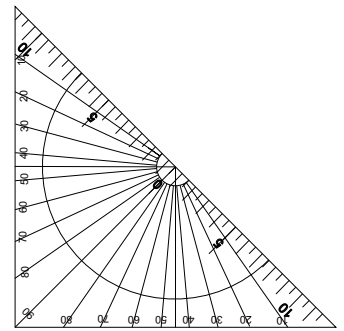
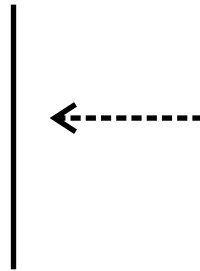

L. Bodart

Éch: \_\_\_\_\_ Date: \_\_\_\_\_ Nom \_\_\_\_\_

Construction géométrique

Classe: \_\_\_\_\_

Les parallèles, perpendiculaires

Exe: \_\_\_\_\_



Tracer des parallèles à 45° distantes de 10 mm  
 ET parallèle à partir d'une droite (hachures)  
 avec une latte et une équerre

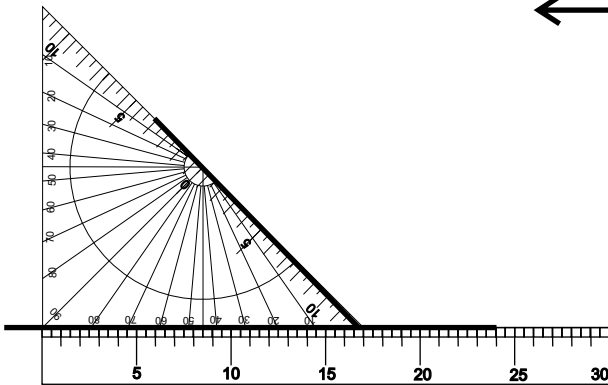
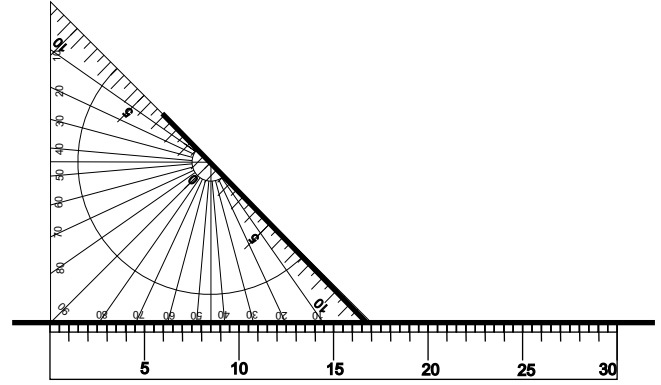
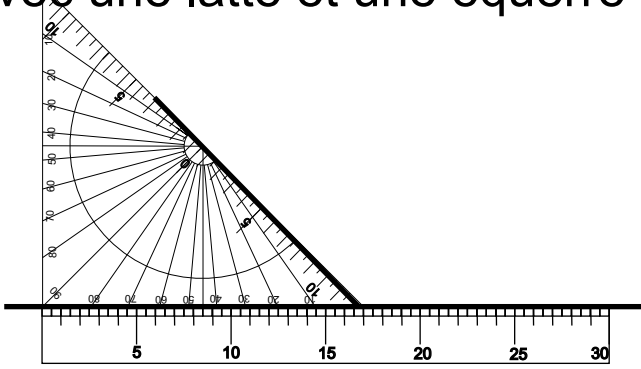

Attention au positionnement des instruments pour respecter les mesures demandées

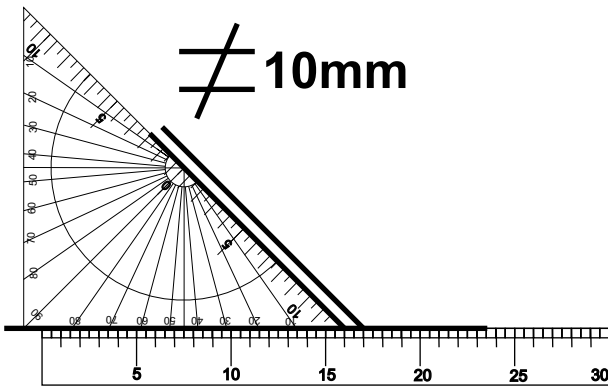
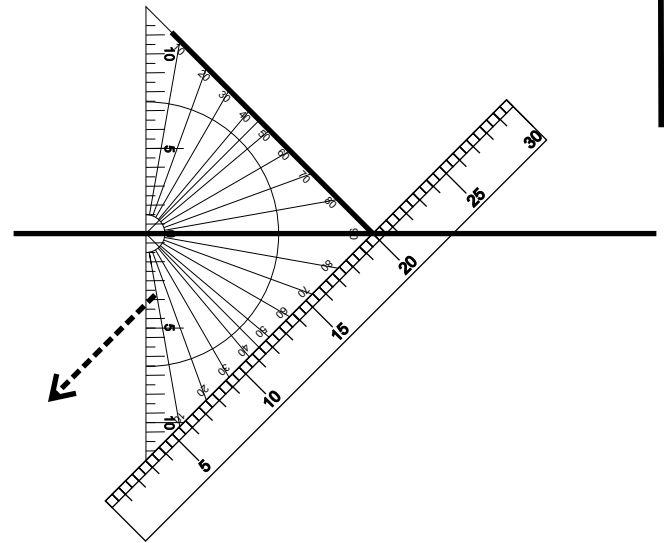

$\neq 10\text{mm}$

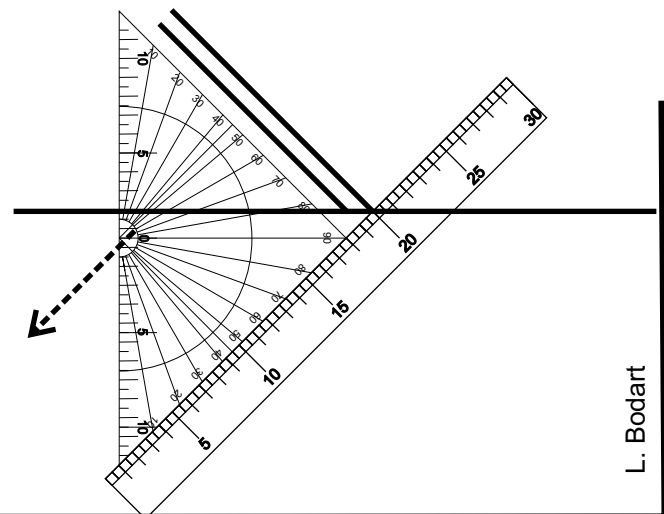

L. Bodart

Éch: \_\_\_\_\_ Date: \_\_\_\_\_ Nom \_\_\_\_\_

Construction géométrique  
 Les parallèles, perpendiculaires

Classe: \_\_\_\_\_  
 Exe: \_\_\_\_\_



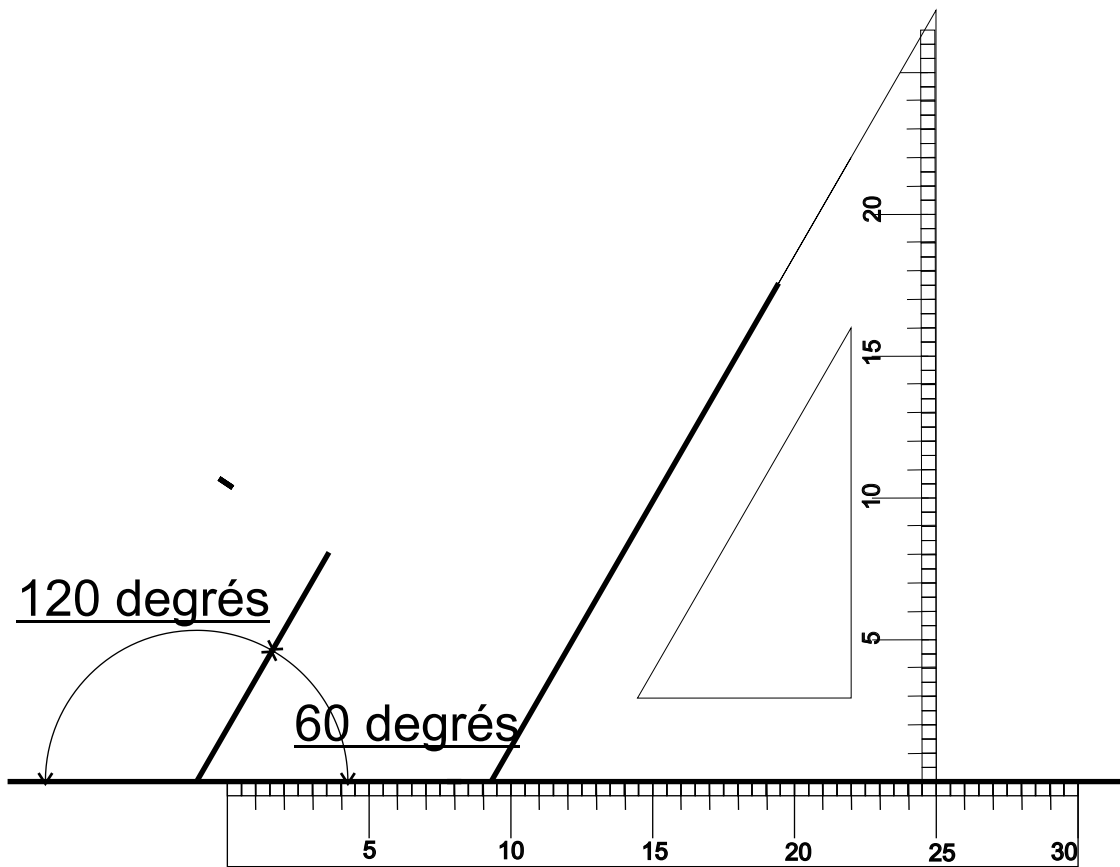
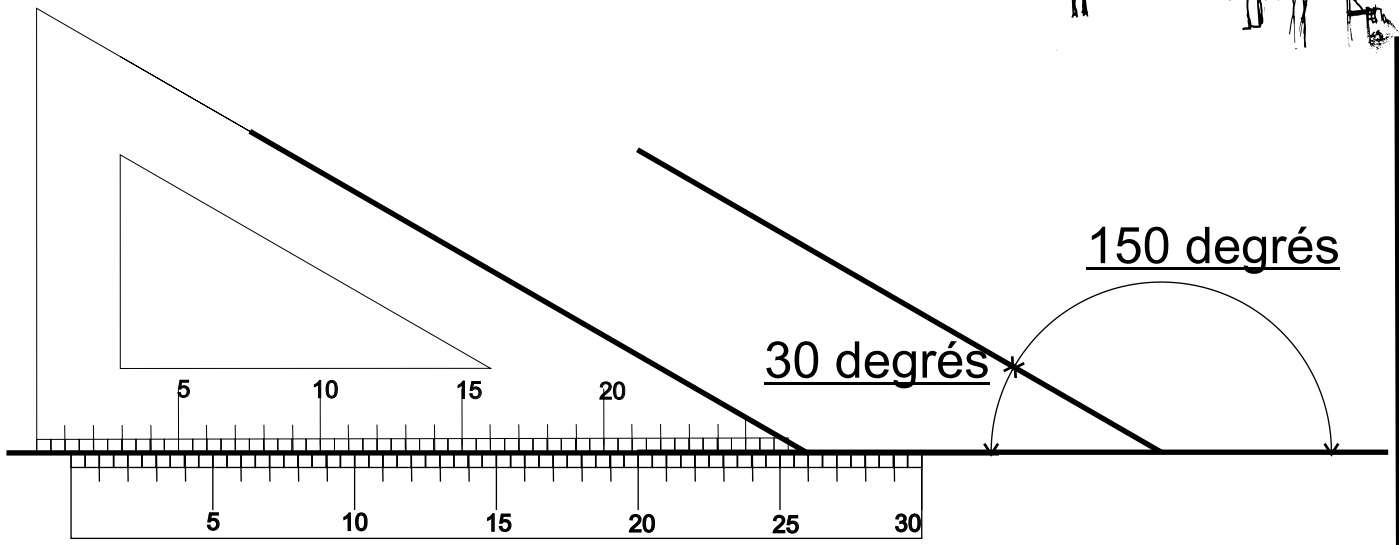

L. Bodart

Éch: \_\_\_\_\_ Date: \_\_\_\_\_ Nom \_\_\_\_\_

Construction géométrique

Classe: \_\_\_\_\_

Les parallèles, perpendiculaires, les angles

Exe: \_\_\_\_\_



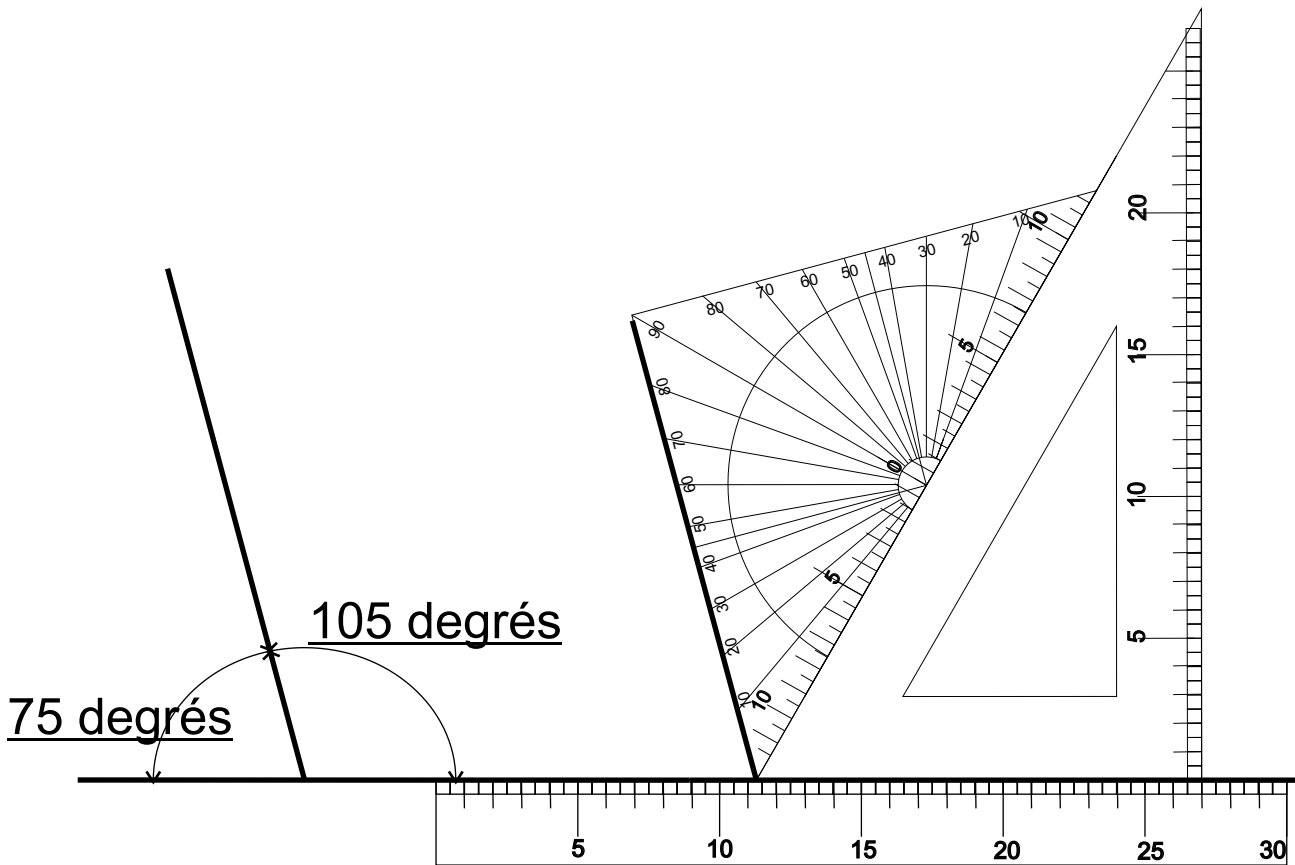
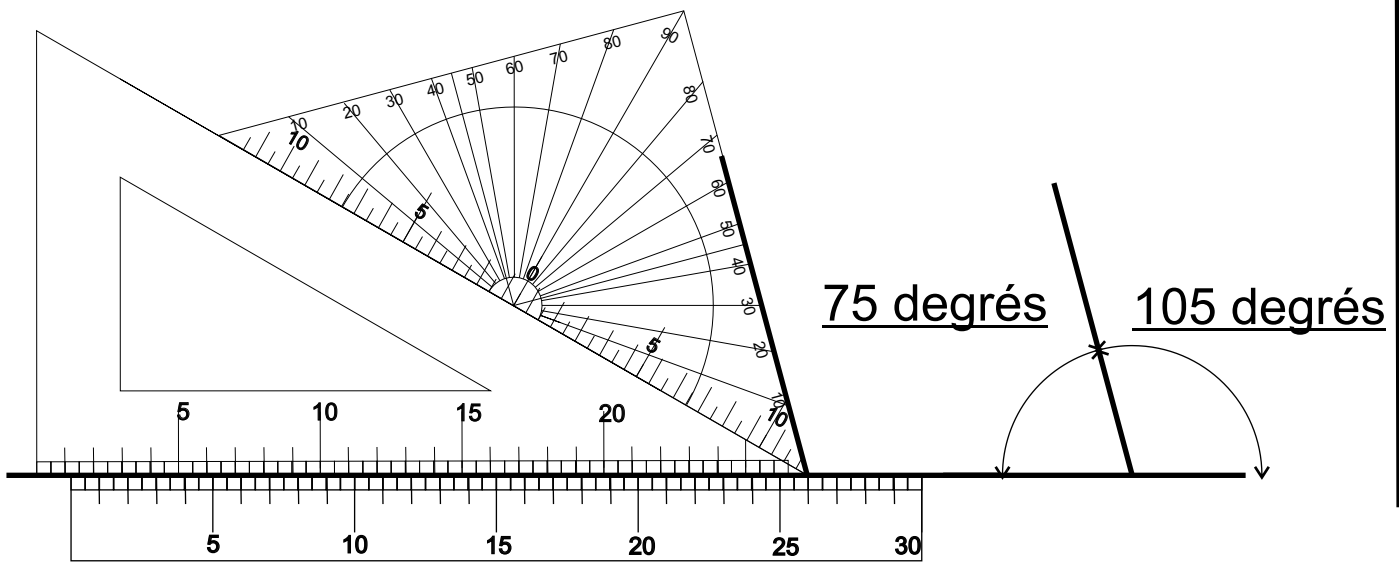

L. Bodart

Éch:	Date:	Nom
Construction géométrique		Classe:
Les parallèles, perpendiculaires, les angles		Exe:
<a href="http://eqba.collegesaintandre.be/">Http://eqba.collegesaintandre.be/</a>		